

后芮驷(上海)电子有限公司

Horus International Electronics Co., LTD.

承认书

SPECIFICATION FOR APPROVAL

编号: _____

品名	DESCRIPTION:	<u>金属板微电阻</u>
规格	SPEC :	<u>HRS-MREXXXXXXXXXXXXXX</u>
包装	PACKAGE:	<u>卷装</u>
客户	CUSTOMER:	_____
客户料号	CUSTOMER P/N:	_____

APPROVED BY

CUSTOMER	 HORUS
-----------------	--



MRE Series Metal Alloy Low-Resistance Resistor Product Specifications

Document No.	S-10-12-06-12
Released Date	2023/12/11
Page No.	1/9

■ Metal Alloy Low Resistance Chip Resistor — MRE Series

■ Application

- Computer
- Power supply
- Measuring instrument
- Industrial
- Battery management system
- Wearable device

■ Features

- Low Resistance / TCR / EMF(Only for MnCu) / Inductance
- Optional Ultra Low Profile available
- RoHs compliant and halogen free.
- down size to 0201.
- High precision current sensing and voltage division.
- High current jumper

■ Product structure

- (1) - Substrate : epoxy
- (2) - Adhesive : epoxy
- (3) - Resistive element : Cu – alloy
- (4) - Terminal electrode : Sn、Ni、Cu
- (5) - Protective coating : Flame-retardant epoxy, meets UL- 94-V0 requirements
- (6) - Marking coating : Flame-retardant epoxy, meets UL- 94-V0 requirements (white)

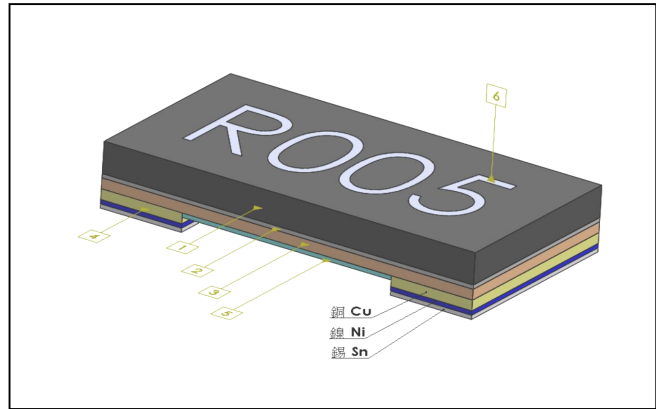

■ Parts number explanation:

Example:

MRE	1206	10	F	R002	M	Z
Product Type	Size (Inch)	Rated Power	Tolerance	Resistance	Material	Optional
	0201 0402 0603 0805 1206 2010	02=0.20W X2=0.25W 03=0.33W 05=0.50W 10=1.00W 15=1.50W Jumper Y6 (for 0201) 01 (for 0603) 02 (for 0402) 0A (for 0805) 03 (for 1206)	F : ±1% *J : ±5% (*for Jumper)	2m50=2.5mR R005=5.0mR R020=20mR *R000=Jumper	M : MnCu *C : Cu (*for Jumper)	Z : Default Code L : Ultra Low Profile Version



MRE Series Metal Alloy Low-Resistance Resistor Product Specifications

Document No. S-10-12-06-12

Released Date 2023/12/11

Page No. 2/9

Standard Electrical Specifications

Type	Rating Power at 70°C	T.C.R. (ppm/°C)	Max. Rating Current	Max. Overload Current	Resistance Range (mΩ)	Material	Operating Temperature Range (°C)
					1.0% (F)		
MRE0201	0.2W	±200	4.47A	7.07A	10 & 20	MnCu	- 55 ~ + 125
MRE0402	0.33W	±150	11.48A	18.16A	2.5,3	MnCu	- 55 ~ + 155
		±100	8.12A	12.84A	5~25		
	0.25W	±100	3.10A	4.90A	26~50		
MRE0603	0.33W	±150	12.84A	20.31A	2		
		±100	11.49A	18.16A	2.5~5		
		±75	7.41A	11.72A	6~20		
MRE0805	0.5W	±100	18.25A	28.86A	1.5		
		±75	15.81A	25.00A	2~5		
		±50	9.12A	14.43A	6~22		
MRE1206	1W	±75	31.62A	50A	1~4		
		±50	14.14A	22.36A	5~20		
MRE2010	1.5W	±50	38.72A	61.23A	1 & 2 & 3		

Ultra Low Profile Electrical Specifications

Type	Rating Power at 70°C	T.C.R. (ppm/°C)	Max. Rating Current	Max. Overload Current	Resistance Range (mΩ)	Material	Operating Temperature Range (°C)
					1.0% (F)		
MRE0805	0.5W	±50	15.81A	25.00A	2~20	MnCu	- 55 ~ + 155

Jumper Specifications

Type	Max. Rating Current	Max. Overload Current	Max Resistance (mΩ)	Operating Temperature Range (°C)
MRE0201	8A	12A	1	- 55 ~ + 125
MRE0402	20A	31.62A	0.5	- 55 ~ + 155
MRE0603	26A	41.07A	0.2	
MRE0805	35A	55.33A	0.2	
MRE1206	40A	64.22A	0.2	



MRE Series Metal Alloy Low-Resistance Resistor Product Specifications

Document No.	S-10-12-06-12
Released Date	2023/12/11
Page No.	3/9

Type Dimension

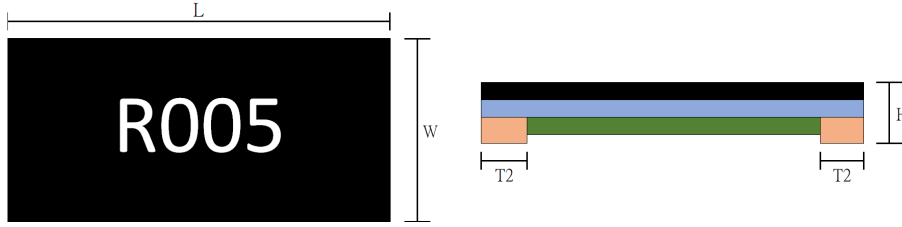

Standard Electrical Dimension

Unit : mm

	Power Rating	Resistance Range	L	W	H	T ₂
MRE0201	0.2W	10mΩ, 20mΩ	0.60±0.15	0.30±0.15	0.25±0.10	0.15±0.10
MRE0402	0.33W	2.5mΩ, 3mΩ	1.00±0.15	0.55±0.15	0.30±0.10	0.30±0.10
		5~25mΩ				0.23±0.10
MRE0603	0.33W	2mΩ	1.60±0.25	0.80±0.25	0.40±0.25	0.45±0.20
		2.5mΩ, 3mΩ				0.35±0.20
		4~20mΩ				0.30±0.20
MRE0805	0.5W	1.5mΩ	2.00±0.25	1.25±0.25	0.40±0.25	0.70±0.20
		2mΩ				0.60±0.20
		3~22mΩ				0.40±0.20
MRE1206	1W	1mΩ	3.20±0.25	1.60±0.25	0.40±0.25	1.25±0.30
		2mΩ				1.05±0.30
		3mΩ				0.80±0.30
		4~20mΩ				0.60±0.30
MRE2010	1.5W	1mΩ	5.08±0.25	2.54±0.25	0.50±0.25	1.85±0.30
		2mΩ				1.30±0.30
		3mΩ				0.70±0.30

Ultra Low Profile Electrical Dimension

Unit : mm

	Power Rating	Resistance Range	L	W	H	T ₂
MRE0805	0.5W	2mΩ	2.00±0.15	1.25±0.15	0.35±0.10	0.55±0.20
		3mΩ				0.35±0.20
		4mΩ~20mΩ			0.30±0.10	



MRE Series Metal Alloy Low-Resistance Resistor Product Specifications

Document No. S-10-12-06-12

Released Date 2023/12/11

Page No. 4/9

■ Jumper Dimension

Unit : mm

	Max Resistance	L	W	H	T ₂
MRE0201	1.0mΩ	0.60±0.15	0.30±0.15	0.25±0.10	0.15±0.10
MRE0402	0.5mΩ	1.00±0.20	0.50±0.20	0.35±0.20	0.20±0.15
MRE0603	0.2mΩ	1.60±0.25	0.80±0.25	0.35±0.25	0.35±0.20
MRE0805	0.2mΩ	2.00±0.25	1.25±0.25	0.35±0.25	0.35±0.20
MRE1206	0.2mΩ	3.20±0.25	1.60±0.25	0.50±0.25	0.50±0.20

■ Performance Characteristics

Power Derating Curve

The Operating Temperature Range: -55°C ~+155°C(0402~2010). -55°C ~+125°C(0201)

For resistors operated in ambient temperatures above 70°C, power rating must be derated in accordance with the curve below

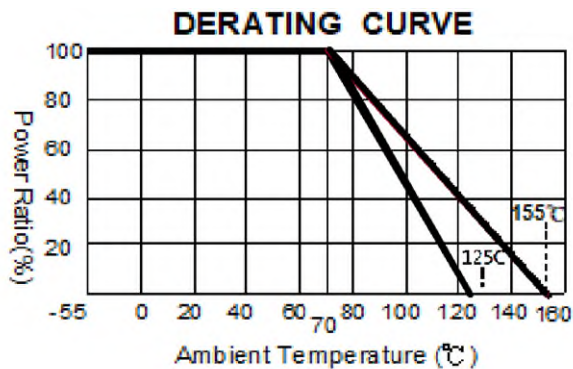

■ Rating Current

The following equation may be used to determine the DC (Direct Current) or AC (Alternating Current) (RMS, root mean square value) of normal rated power. However, if the result value exceeds the highest current of regulated standards (paragraph 5), the highest normal rated power is to be used

$$I = \sqrt{P/R}$$

I = Rating current (A)
 P = Rating Power (W)
 R = Resistance(Ω)



MRE Series Metal Alloy Low-Resistance Resistor Product Specifications

Document No. S-10-12-06-12

Released Date 2023/12/11

Page No. 5/9

■ Reliability Test and Requirement

Test Item	Test Method	Procedure	Requirements
Temperature Coefficient of Resistance (T.C.R)	JIS-C-5201-1 4.8 IEC-60115-1 4.8	At 25°C /+125°C, 25°C is the reference temperature	As Spec
Short Time Overload	JIS-C-5201-1 4.13 IEC-60115-1 4.13	The number of rated power are as follows: 2.5 times of rated power for 5 seconds.	±1.0%+0.5mΩ
High Temperature Exposure	JIS-C5201-1 4.25 IEC 60068-2-2	At 155°C for 1000 hours.(0402~2010) At 125°C for 1000 hours.(0201)	±1.0%+0.5mΩ Jumper : < Rmax
Low Temperature Storage	JIS-C-5201-1 4.23.4 IEC60115-1 4.23.4	At -55°C for 1000 hours	±1.0%+0.5mΩ Jumper : < Rmax
Resistance to Soldering Heat	JIS-C-5201-1 4.18 IEC-60115-1 4.18	260±5°C for 10 seconds.	±1.0%+0.5mΩ Jumper : < Rmax
Damp Heat with Load	JIS-C-5201-1 4.24 IEC-60115-1 4.24	40±2°C, 90~95% R.H. RCWV or Max. working voltage whichever is less for 1000 hrs with 1.5 hrs "ON" and 0.5 hr "OFF" .	±2.0%+0.5mΩ Jumper : < Rmax
Rapid Change of Temperature	JIS-C-5201-1 4.19 IEC-60115-1 4.19	-55°C to +155°C,100 cycles(0402~2010) -55°C to +125°C,100 cycles(0201)	±1.0%+0.5mΩ Jumper : < Rmax
Load Life (Endurance)	JIS-C-5201-1 4.25 IEC-60115-1 4.25.1	70±2°C, RCWV or Max. working voltage whichever is less for 1000 hrs with 1.5 hrs "ON" and 0.5 hr "OFF" .	±2.0%+0.5mΩ Jumper : < Rmax
Solderability	JIS-C-5201-1 4.17 IEC-60115-1 4.17	245±5°C for 3 seconds.	The covered area >95%
Mechanical Shock	JIS C 5202 6.7	a =50G , t =11ms, 5 times shock	±1.0%+0.5mΩ
Bending Strength	JIS-C-5201-1 4.33 IEC-60115-1 4.33	Bending once 2mm for 10 seconds	±1.0%+0.5mΩ



MRE Series Metal Alloy Low-Resistance Resistor Product Specifications

Document No.	S-10-12-06-12
Released Date	2023/12/11
Page No.	6/9

■ Marking Format:

- 0201&0402 type no marking
- 0603 type products marking are 2 or 3 digits
e.g. 2 digits
10mΩ the product marking is 10.
15mΩ the product marking is 15
e.g. 3 digits
“M” designates the decimal location in milli-ohms
2.5mΩ the product marking is 2M5
- 0805 type products marking are 3 digits.
“M” designates the decimal location in milli-ohms
e.g. 10mΩ the product marking is 010.
1.5mΩ the product marking is 1M5
- 1206 & 2010 type products marking are 4 digits.
“R” designates the decimal location in ohms
e.g. 1mΩ the product marking is R001.
20mΩ the product marking is R020.
“M” designates the decimal location in milli-ohms
e.g. 0.25mΩ the product marking is 0M25.
0.5mΩ the product marking is 0M50.
5.5mΩ the product marking is 5M50.
- The criteria to distinguishing the mark on the surface of products are that characters can be identified.
- Jumper & Ultra Low Profile Product NO Marking

● Recommended Customer Soldering Parameters

■ Solder reflow Temperature condition

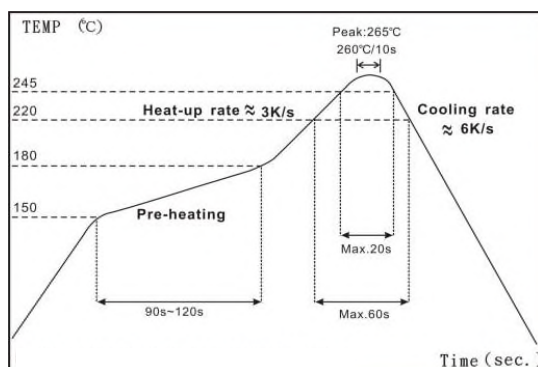

■ Rework temperature (hot air equipment) : 350°C, 3~5seconds

■ Recommended reflow methods

IR, vapor phase oven, hot air oven

If reflow temperatures exceed the recommended profile, devices may not meet the performance requirements.



MRE Series Metal Alloy Low-Resistance Resistor Product Specifications

Document No. S-10-12-06-12

Released Date 2023/12/11

Page No. 7/9

Recommend Land Pattern Design

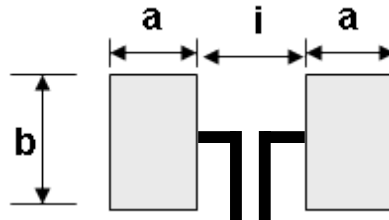

Standard & Ultra Low Profile Electrical Dimension

Unit: mm

Type	Resistance Range	a	b	i
MRE0201 – 0.2W	10mΩ, 20mΩ	0.20	0.33	0.25
MRE0402 – 0.33W	2.5mΩ, 3mΩ	0.60	0.60	0.35
	5mΩ~25mΩ	0.60	0.60	0.40
MRE0402 – 0.25W	26mΩ~50mΩ	0.60	0.60	0.40
MRE0603 – 0.33W	2mΩ	1.41	0.92	0.38
	2.5mΩ,3mΩ	1.35	0.92	0.5
	4mΩ~20mΩ	1.30	0.92	0.6
MRE0805 – 0.5W	1.5mΩ,2mΩ	1.55	1.44	0.50
	3mΩ~22mΩ	1.40	1.44	0.80
MRE1206 – 1W	1mΩ	2.15	1.84	0.50
	2mΩ	2.10	1.84	0.60
	3mΩ~20mΩ	1.80	1.84	1.20
MRE2010 – 1.5W	1mΩ	2.70	2.88	0.9
	2mΩ	2.30	2.88	1.80
	3mΩ	1.85	2.88	2.7

Jumper Dimension

Unit: mm

Type	Max Resistance	a	b	i
MRE0201 – 0.064W	1.0mΩ	0.20	0.33	0.25
MRE0402 – 0.2W	0.5mΩ	0.60	0.60	0.40
MRE0603 – 0.135W	0.2mΩ	1.30	0.92	0.60
MRE0805 – 0.245W	0.2mΩ	1.40	1.44	0.80
MRE1206 – 0.33W	0.2mΩ	1.80	1.84	1.20



MRE Series Metal Alloy Low-Resistance Resistor Product Specifications

Document No. S-10-12-06-12

Released Date 2023/12/11

Page No. 8/9

■ Packing Quantity

Type	PCS / Reel
MRE0201	10,000
MRE0402	10,000
MRE0603	5,000
MRE0805	5,000
MRE1206	5,000
MRE2010	4,000

■ Appendix For SMD Chip Resistor

● Packaging Information

■ Reel Dimensions

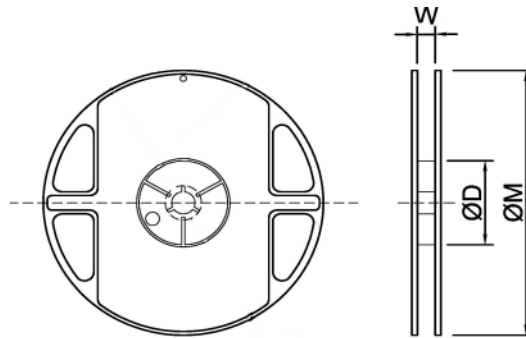

■ Dimension

Unit: mm

Type	ϕD	W	ϕM
MRE0201	60±2	9.0±0.5	178±5
MRE0402			
MRE0603			
MRE0805			
MRE1206			
MRE2010			



MRE Series Metal Alloy Low-Resistance Resistor Product Specifications

Document No.	S-10-12-06-12
Released Date	2023/12/11
Page No.	9/9

Carrier Dimensions

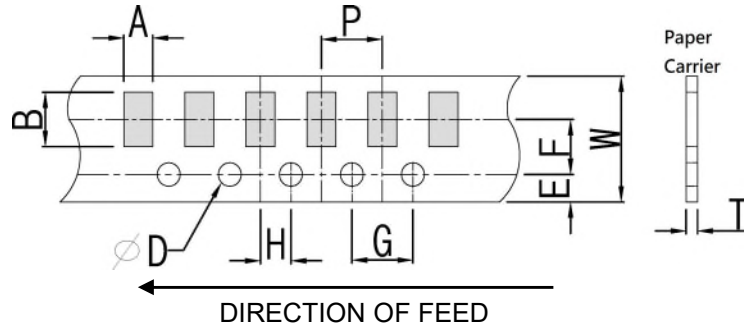

Dimension

Unit: mm

Item	W	P	E	F	φD	G	H	A	B	T		
										Standard	Jumper/ Ultra Low Profile	
MRE0201	8.0±0.30	2.0±0.10	1.75±0.10	3.5±0.10	1.50 ^{+0.1} ₀	4.0±0.10	2.0±0.10	0.40±0.20	0.70±0.20	0.45±0.05	0.45±0.05	
MRE0402								0.65±0.20	1.10±0.20	0.42±0.05	0.42±0.05	
MRE0603		4.0±0.10						0.75±0.20	0.98±0.20	1.85±0.20	0.60±0.10	0.58±0.10
MRE0805									1.55±0.20	2.30±0.20	0.58±0.20	
MRE1206									2.05±0.20	3.65±0.20	0.75±0.20	

Embossed Dimensions

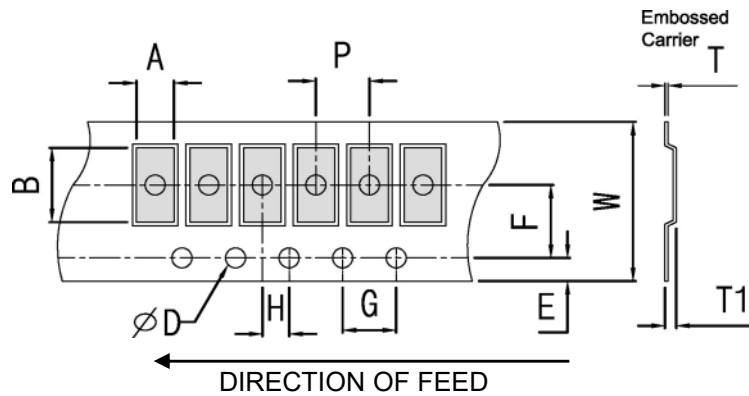

Dimension

Unit: mm

Item	W	P	E	F	φD	G	H	A	B	T1	T
MRE2010	12.0±0.30	4.0±0.10	1.75±0.10	5.5±0.10	1.50 ^{+0.1} ₀	4.0±0.10	2.0±0.10	2.85±0.20	5.45±0.20	0.80±0.20	0.25±0.10

Peeling Strength of Seal Tape

Peeling Strength: 0.1 – 1.0N (10 - 100gf)

Storage Temperature

Storage time at the environment temp: 25±5°C & humidity: 60±20% is valid for one year from the date of delivery